

- Chemistry of Minor Bases of tRNA"; International Conference: Poznań-Kiekrz, Poland, 1974; pp 192-222.
- (18) Barrell, B. G.; Clark, B. F. C. "Handbook of Nucleic Acid Sequences"; Joynson-Bruvvers: Oxford, 1974.
- (19) Dunn, D. B. *Biochim. Biophys. Acta* **1961**, *46*, 198.
- (20) Littlefield, J. W.; Dunn, D. B. *Biochem. J.* **1958**, *70*, 642.
- (21) Dunn, D. B.; Smith, J. D.; Spahr, P. F. *J. Mol. Biol.* **1960**, *2*, 113.
- (22) Saneyoshi, M.; Harada, F.; Nishimura, S. *Biochim. Biophys. Acta* **1969**, *190*, 264.
- (23) Saneyoshi, M.; Ohashi, Z.; Harada, F.; Nishimura, S. *Biochim. Biophys. Acta* **1972**, *262*, 1.
- (24) Wang, A. H. J.; Dammann, L. G.; Barrio, J. R.; Paul, I. C. *J. Am. Chem. Soc.* **1974**, *96*, 1205.
- (25) Spencer, R. D.; Weber, G.; Tolman, G. L.; Barrio, J. R.; Leonard, N. J. *Eur. J. Biochem.* **1974**, *45*, 425.
- (26) Barrio, J. R.; Sattangi, P. D.; Gruber, B. A.; Dammann, L. G.; Leonard, N. J. *J. Am. Chem. Soc.* **1976**, *98*, 7408.
- (27) Shaw, G.; Smallwood, B. M. *J. Chem. Soc. C* **1970**, 2206.
- (28) Fleysner, M. H.; Bloch, A.; Hakala, M. T.; Nichol, C. A. *J. Med. Chem.* **1969**, *12*, 1056.
- (29) Leonard, N. J.; Achmalowicz, S.; Loepky, R. N.; Carraway, K. L.; Grimm, W. A.; Szweykowska, A.; Hamzi, H. Q.; Skoog, F. *Proc. Natl. Acad. Sci. U.S.A.* **1966**, *56*, 709.
- (30) Jones, J. W.; Robins, R. K. *J. Am. Chem. Soc.* **1963**, *85*, 193.
- (31) Kissman, H. M.; Weiss, M. J. *J. Org. Chem.* **1956**, *21*, 1053.
- (32) Johnson, J. A.; Thomas, H. J.; Schaeffer, H. J. *J. Am. Chem. Soc.* **1958**, *80*, 699.
- (33) Singer, B. *Prog. Nucleic Acid Res. Mol. Biol.* **1975**, *15*, 219, and references cited therein.
- (34) Singer, B.; Sun, L.; Fraenkel-Conrat, R. *Biochemistry* **1974**, *13*, 1913.
- (35) Ainsworth, C. *J. Am. Chem. Soc.* **1956**, *78*, 1635.
- (36) The conditions tried included the use of High Active Nickel Grade 30 (W. R. Grace and Co., Davison Chemical Division, Baltimore, Md.) over an extended period of vigorous mechanical stirring.
- (37) Miller, C. O.; Skoog, F.; Okumura, F. S.; Von Salza, M. H.; Strong, F. M. *J. Am. Chem. Soc.* **1956**, *78*, 1375.
- (38) Lister, J. H. "Fused Pyrimidines", Part II, "Purines", Brown, D. J., Ed.; Wiley-Interscience: New York, 1971; p 322.
- (39) Zemlička, J.; Hóly, A. *Collect. Czech. Chem. Commun.* **1967**, *32*, 3159.
- (40) Zemlička, J. *Collect. Czech. Chem. Commun.* **1963**, *28*, 1060.
- (41) Park, M.; Isemura, H.; Yuki, H.; Takiura, K. *Yakugaku Zasshi* **1975**, *95*, 68.
- (42) When our work was in progress, independent publications confirmed this alternative hypothesis of the order of ring closure by means of kinetic data: (a) Kochelkov, N. R.; Shibaev, V. N.; Kosi, A. A.; Razzhivin, A. P.; Ermolin, S. V. *Dokl. Akad. Nauk SSSR* **1977**, *234*, 1339; and UV, NMR, and MS data: (b) Biernat, J.; Ciesiolka, J.; Górnicki, P.; Adamiak, R. W.; Krzyżosiak, W. J.; Wiewiórowski, M. *Nucleic Acid Res.* **1978**, *5*, 789; (c) Krzyżosiak, W. J.; Biernat, J.; Ciesiolka, J.; Górnicki, P.; Wiewiórowski, M. *Pol. J. Chem.* **1979**, *53*, 243.
- (43) Borch, R. F.; Durst, H. D. *J. Am. Chem. Soc.* **1969**, *91*, 3996.
- (44) Borch, R. F.; Bernstein, M. D.; Durst, H. D. *J. Am. Chem. Soc.* **1971**, *93*, 2897.
- (45) Leonard, N. J.; Paukstelis, J. V. *J. Org. Chem.* **1963**, *28*, 3021.
- (46) Hecht, S. M.; Gupta, A. S.; Leonard, N. J. *Anal. Biochem.* **1969**, *30*, 249.
- (47) Biemann, K. "Mass Spectrometry"; McGraw-Hill: New York, 1962; p 351.
- (48) Biemann, K.; McCloskey, J. A. *J. Am. Chem. Soc.* **1962**, *84*, 2005.
- (49) Hanessian, S.; Dejongh, D. C.; McCloskey, J. A. *Biochim. Biophys. Acta* **1966**, *117*, 480.
- (50) (a) Kuramochi, T.; Inoue, Y. "Abstracts of Papers", 11th Congress of Heterocyclic Chemistry, Kanazawa, Japan, 1978; pp 333-337. (b) Kuramochi, T.; Inoue, Y.; Imakubo, K. *Chem. Lett.* **1979**, 115. (c) Inoue, Y.; Kuramochi, Y.; Imakubo, K. "Abstracts of Papers", ACS/CSJ Chemical Congress, Honolulu, Hawaii, April 1979; American Chemical Society: Washington, D.C., 1979; BIOL 29.
- (51) Scott, T. G.; Spencer, R. D.; Leonard, N. J.; Weber, G. *J. Am. Chem. Soc.* **1970**, *92*, 687.

## Stereochemical Study of the [3,3] Sigmatropic Rearrangement of 1,5-Diene-3-alkoxides. Application to the Stereoselective Synthesis of ( $\pm$ )-Juvabione

David A. Evans\* and John V. Nelson<sup>1</sup>

Contribution No. 5827 from the Laboratories of Chemistry,  
California Institute of Technology, Pasadena, California 91125.  
Received July 13, 1978

**Abstract:** A study was carried out on the [3,3] sigmatropic rearrangement of the potassium salts of the individual dienols **6a**, **6b**, **7a**, and **7b**. It has been found that these rearrangements proceed in a concerted fashion predominately via chair transition states to give the diastereoisomeric ketones **8** and **9**. The application of these modified oxy-Cope rearrangements to the synthesis of ( $\pm$ )-erythro-juvabione (**15a**) is reported.

### Introduction

In 1975 we reported the observation that the oxy-Cope rearrangement of diene alkoxide **1a** proceeded at approximately  $10^{12}$  times the rate of the corresponding alcohol **1b** (eq 1).<sup>2</sup> In subsequent investigations, we<sup>3</sup> and others<sup>4</sup> have established that these initial alkoxide-promoted rate accelerations are generalizable to other systems (eq 2 and 3).

In spite of the apparently "concerted" nature of these rearrangements, only one published experiment bears on this important issue.<sup>2</sup> In this regard, we found that, under conditions in which **1a** underwent rearrangement with a half-life of 1.4 min (THF, 60 °C), the diastereoisomeric alkoxide **3** was stable for ca. 24 h. While these experiments contribute permissive evidence for the concerted nature of the transformation of **1a**  $\rightarrow$  **2a**, it does *not* rule out a nonsynchronous mechanism. The observations could be equally well explained by assuming that single-bond cleavage occurs in both substrates via either a homolytic or heterolytic pathway<sup>5</sup> but that the rotational barrier for the interconversion of these intermediates (cf. **4** and

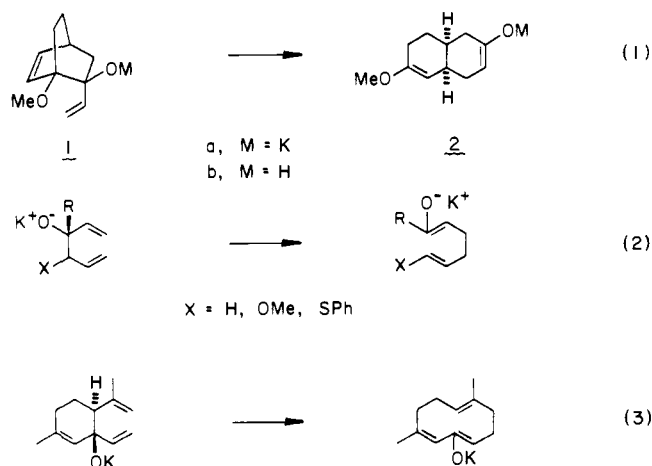

**5**) is large relative to the recombination barrier **5**  $\rightarrow$  **3** (Scheme I, homolysis).

Scheme I

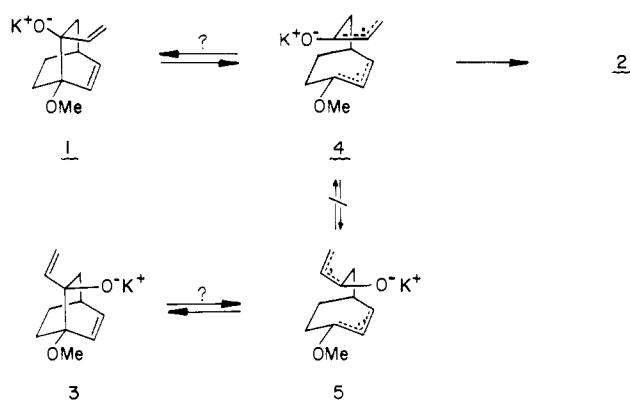

In the present study, two sets of diastereoisomeric dienols **6a**, **6b** and **7a**, **7b** were chosen as informative substrates. In the rearrangement of dienols **6ab** and **7ab**, it should be possible to

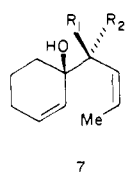
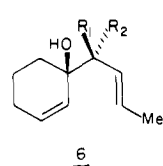

**a**: R<sub>1</sub> = H, R<sub>2</sub> = OMe  
**b**: R<sub>1</sub> = OMe, R<sub>2</sub> = H

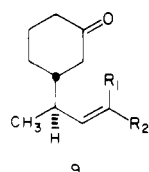
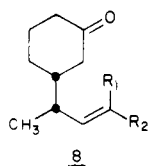

**i**: R<sub>1</sub> = H, R<sub>2</sub> = OMe  
**s**: R<sub>1</sub> = OMe, R<sub>2</sub> = H

Scheme II

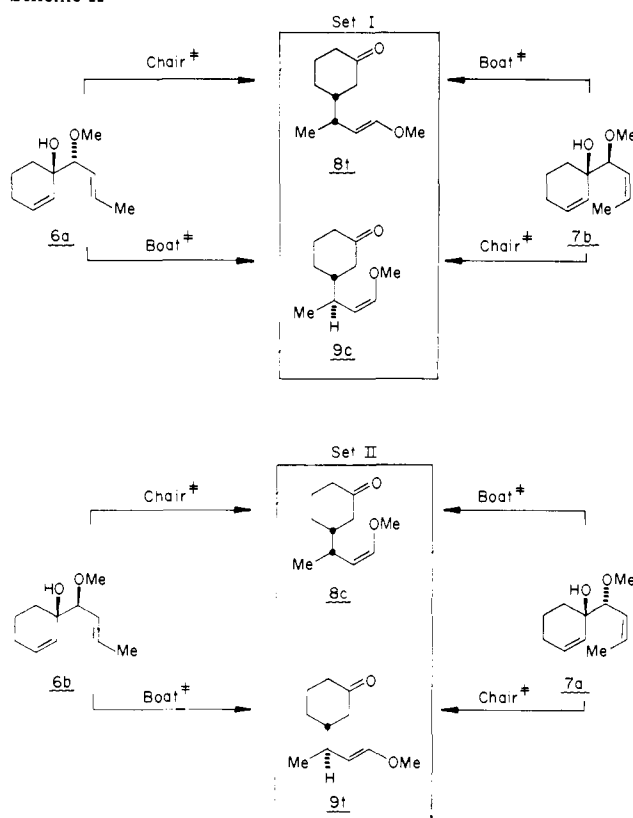

examine two structural features associated with each reaction: transfer of chirality and creation of specific product olefin geometry.

As illustrated in Scheme II, if any given dienol underwent *concerted* rearrangement, *only* two predictable ketonic products (product set I or II) would be produced via chair and boat transition states (e.g., **6a** → **8t** + **9c**). *In the event that all four dienols rearranged in a concerted fashion, the dienol pair 6a and 7b will afford only ketones 8t and 9c (set I), while dienols 6b and 7a will give only ketones 8c and 9t (set II).* If the above situation were found to be the case, complete *erythro*- and *threo*-dienol stereochemical assignments can be *unambiguously* made for the diastereoisomeric *trans*-olefin pair **6a**, **6b** and *cis*-olefin pair **7a**, **7b**. On the other hand, from any given dienol, the co-occurrence of more than two ketone rearrangement products or a combination of any two products derived from sets I and II constitutes unequivocal evidence for nonconcerted rearrangement from that substrate.

## Results and Discussion

**Substrate Synthesis.** The four dienols **6a,b** and **7a,b** were prepared via stereoselective *trans* and *cis* reduction of the diastereoisomeric hydroxy acetylenes **11**. Metallation of 1-methoxy-2-butyne<sup>6</sup> with *n*-butyllithium (-70 °C, 30 min) followed by the addition of zinc chloride (1 equiv) resulted in the formation of the presumed organozinc reagent **10** (eq 4).<sup>7</sup>

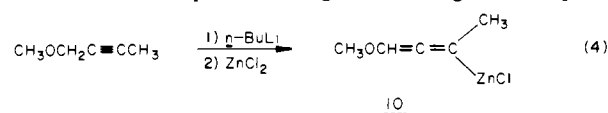

The addition of cyclohexenone to **10** afforded the acetylenic alcohol **11** in 95% yield as a 65:35 mixture of diastereoisomers. A number of the advertised procedures for the reduction of acetylenes to *trans*-olefins were found to convert acetylene **11**

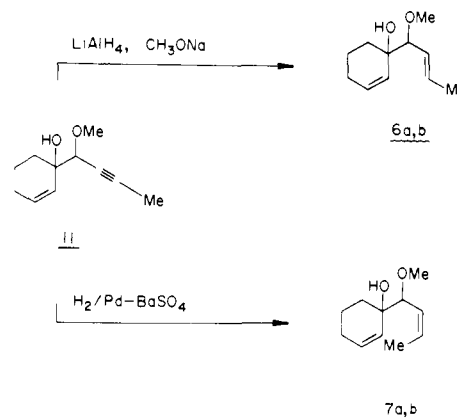

to a mixture of *trans*-olefin **6** and a compound whose spectra were consistent with the allene, 1-(1,2-butadienyl)-2-cyclohexen-1-ol (**12**). For example, sodium/ammonia reduction<sup>8</sup> gave an 80:20 ratio of **6**:**12** in 90% yield, while lithium aluminum hydride<sup>9</sup> afforded a 94:6 ratio of **6**:**12** in only 60% yield due to over-reduction. However, it was found that a 1:2 molar ratio of LiAlH<sub>4</sub>:CH<sub>3</sub>ONa<sup>10</sup> completely suppressed over-reduction and afforded an 85% yield of **6a,b** containing only a trace (1%) of allene **12** and *cis*-alcohols **7a,b** (≤1%). Presumably, **12** is formed by elimination of methoxide from a vinyl anion intermediate; thus, the success of the mixed reagent may be due to delivery of the hydride predominantly to the acetylene carbon nearest the hydroxyl. Although these conditions are known to effect delivery of the hydride exclusively to the acetylene carbon proximal to the hydroxyl function in propargylic alcohols,<sup>10</sup> its success in a homopropargylic system was a pleasant surprise and poses some interesting mechanistic questions. The diastereoisomeric mixture of *cis*-dienols **7a,b**

was obtained in 76% yield by catalytic hydrogenation of **11** over palladium on barium sulfate poisoned with quinoline<sup>11</sup> (**6a,b**:**7a,b** = 3:97). The two sets of diastereoisomeric alcohols **6a,b** and **7a,b** were cleanly separated by chromatography on silica gel impregnated with silver nitrate.<sup>12</sup> Although independent stereochemical assignments were not determined for the two sets of *erythro-threo*-alcohols, the following study (vide infra) leads to the unambiguous stereochemical assignments for **6a**, **6b**, **7a**, and **7b** as denoted in Scheme II.

**Sigmatropic Rearrangements.** Initial rearrangements were carried out on the unseparated diastereoisomeric *trans*-dienol mixture **6a**, **6b** to determine optimal conditions and yields. In numerous preparative runs, it was found that the potassium alkoxides derived from **6a**, **6b** (65:35) completely rearranged in diglyme at 110 °C over a 38-h period to the mixture of ketonic products **8** and **9** in 75–80% isolated yields. Under identical conditions, the potassium alkoxides derived from the diastereoisomeric *cis*-dienols **7a**, **7b** (65:35) afforded, in addition to the desired ketones **8** and **9**, a 40% yield of an unstable trienol derived from the base-catalyzed elimination of methanol. Proton NMR analysis suggested its structure to be 1-(1,3-butadienyl)-2-cyclohexen-1-ol. In contrast, the attempted *thermal* rearrangement of *trans*-dienol mixture **6a,b** (250 °C, 4 h) was totally unsuccessful yielding products derived from  $\beta$ -hydroxy olefin cleavage, recovered starting material and intractable polymeric byproducts.

Structure determination of the ketonic rearrangement products **8t**, **9c**, **8c**, and **9t** was accomplished by combined degradation and spectroscopic techniques. Determination of the relative stereochemical relationships between the ring and methyl-bearing side chain stereocenters for sets of ketones **8** and **9** was accomplished by degradation (O<sub>3</sub>, CrO<sub>3</sub>) of the respective ketones to the *erythro*- and *threo*-keto acids **13a** and **13b**. The structures of these diastereoisomeric acids have been

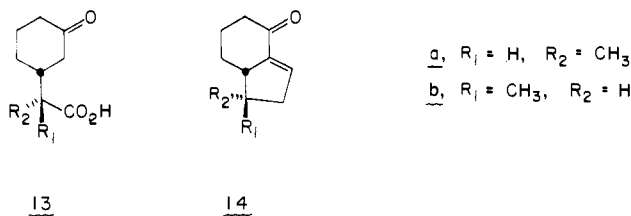

unequivocally established by X-ray analysis.<sup>13,14</sup> It was found that product diastereoisomer analysis (**8t** + **8c**:**9t** + **9c**) was most conveniently carried out by gas chromatography on the bicyclic ketones **14a** and **14b** which were readily obtained from the respective ketones **8a,b** and **9a,b** in excellent yield by acid-catalyzed aldol condensation.

No single analytical technique was found to be suitable for complete reaction product analysis. Nonetheless, the *pairs* of diastereoisomeric *trans*-olefinic ketones (**8t** + **9t**) could be readily resolved from the *cis*-olefinic ketones (**8c** + **9c**) analytically by gas chromatography to give product ratio,  $R_1$  (**8t** + **9t**):(**8c** + **9c**), for each rearrangement experiment. This ratio was also cross-checked by <sup>1</sup>H NMR analysis of the unpurified product mixture. The vinyl protons (–CH=CHOMe) for the *trans* isomer pair appeared at 6.20 ppm ( $J = 13$  Hz), while the *cis* isomer pair appeared at 5.88 ppm ( $J = 6$  Hz). The successful determination of the diastereoisomer ratios,  $R_2$ -*trans* (**8t**:**9t**) and  $R_2$ -*cis* (**8c**:**9c**), was based on the observation that the *trans*-olefin pair (**8t** + **9t**) could be separated from the *cis*-olefin pair (**8c** + **9c**) by medium pressure column chromatography. Accordingly, for each experiment the diastereoisomer ratios  $R_2$ -*trans* (**8t**:**9t**) and  $R_2$ -*cis* (**8c**:**9c**) were determined by the following procedure: (a) preparative chromatographic separation of the *trans* and *cis* isomer pairs (**8t** + **9t**) and (**8c** + **9c**); (b) acid-catalyzed aldol condensation of each isomer pair to the diastereoisomeric ketones **14a** and **14b**

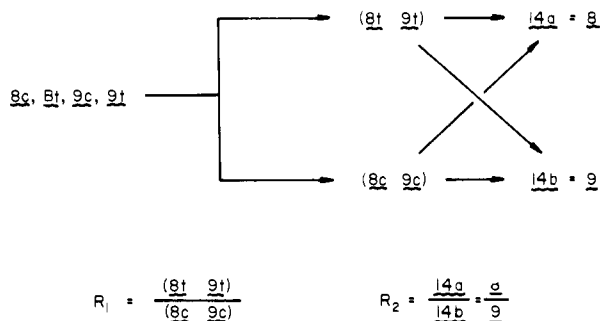

which were readily resolved by GLC; (c) GLC analysis to determine the product ratios,  $R_2$ -*trans* and  $R_2$ -*cis* (**14a**:**14b** = **8**:**9**) and consequently the ratios **8t**:**9t** and **8c**:**9c**. Thus, for each experiment, the determination of ratios  $R_1$ ,  $R_2$ -*cis*, and  $R_1$ ,  $R_2$ -*trans* enabled the complete product analysis, **8c**:**8t**:**9c**:**9t**, to be determined.

The *erythro* and *threo* diastereoisomers of the *trans*-dienols **6a** and **6b** were separated by column chromatography. The first-eluted major isomer, called *trans*-dienol A, was treated with KH (diglyme, 110 °C, 37.5 h). Product analysis by analytical GLC (Carbowax 20M) indicated a *trans*:*cis* ratio (**8t** + **9t**):(**8c** + **9c**) = 96:4. The *trans* isomers (**8t** + **9t**) were separated from the *cis* isomers (**8c** + **9c**) by medium-pressure chromatography. Treatment of the *trans* pair (**8t** + **9t**) containing 1% of *cis* pair with acid (THF, H<sub>2</sub>SO<sub>4</sub>, 4 h) afforded a ratio of **14a**:**14b** (**8t**:**9t**) = 98:2 by analytical GLC (Carbowax 20M). When corrected for the 1% *cis* pair contamination in (**8t** + **9t**), the ratio of **8t**:**9t** was calculated to be 99:1. Similar treatment of the *cis* isomer pair (**8c** + **9c**) afforded a ratio of **14a**:**14b** (**8c**:**9c**) = 4:96. Therefore, the product ratio derived from *trans*-dienol A was found to be: **8t** (96%), **9c** (4%), **8c** ( $\leq 1\%$ ), **9t** ( $\leq 1\%$ ). Following the identical analytical procedure, the second-eluted *trans*-dienol isomer, called *trans*-dienol B, was subjected to the identical rearrangement conditions. Product analysis was carried out as described above for the diastereoisomeric *trans*-alcohol A. The product ratio derived from *trans*-dienol B was found to be: **8t** ( $\leq 1\%$ ), **9c** ( $\leq 1\%$ ), **8c** (77%), **9t** (23%). These results confirm that *trans*-dienol A affords  $\geq 99\%$  product set I (**8t** + **9c**), while *trans*-dienol B affords  $\geq 99\%$  product set II (**8c** + **9t**). Because of the absence of crossover products (within experimental error), the product distribution obtained from the rearrangement of the diastereoisomeric *trans* alcohols A and B indicates that the stepwise rearrangement is not occurring ( $\leq 1\%$ ).

In a parallel series of experiments, the *erythro* and *threo* diastereoisomers of the *cis*-dienols **7a** and **7b** were separated by column chromatography. The first-eluted major isomer, called *cis*-dienol A, obtained in 99% isomeric purity (1% *trans*-dienol A), was subjected to rearrangement and subsequent product analysis according to the identical format as described above. The ratio (**8t** + **9t**):(**8c** + **9c**) was determined to be 98:2 by GLC analysis. Chromatographic separation of the *trans* (**8t** + **9t**) and *cis* isomer (**8c** + **9c**) pairs was carried out as previously described. Consecutive acid-catalyzed aldol condensation and GLC analysis of the *trans* pair (**8t** + **9t**) afforded a ratio of **14a**:**14b** (**8t**:**9t**) = 2:98. After correction for the 1% *trans*-dienol A contaminant (vide infra), the ratio **8t**:**9t** was calculated to be 1:99. Unfortunately, due to the small quantities of the *cis* pair (**8c** + **9c**) produced from *cis*-dienol A (2%), we were unable to determine the ratio **8c**:**9c**. Nonetheless, the value of **8c** + **9c** = 2% indicated that the most conservative estimate for the extent of crossover is 2%. Therefore, the product ratio derived from *cis*-dienol A was found to be: **8t** ( $\leq 1\%$ ), **9c** (0–2%), **8c** (2–0%), **9t** (98%). Following the identical procedure, the second-eluted minor *cis*-dienol isomer, called *cis*-dienol B, was subjected to identical rearrangement conditions and product analysis. The observed

product ratio derived from *cis*-dienol **B** was found to be: **8t** (30%), **9c** (70%), **8c** ( $\leq 1\%$ ), **9t** ( $\leq 1\%$ ). These results confirm that *cis*-dienol **A** affords  $\geq 98\%$  product set II (**8c** + **9t**), while *cis*-dienol **B** affords  $\geq 99\%$  product set I (**8t** + **9c**). Within the experimental error of our analytical scheme ( $\pm 2\%$ ), no significant crossover was detected in the rearrangement of either *cis*-dienol **A** or **B**, again indicating that the stepwise rearrangement is not occurring to an appreciable extent.

**Alcohol Stereochemical Assignments.** The foregoing data clearly indicate that all four isomeric dienol alkoxides rearrange via highly ordered transition states, and that no evidence for competing nonconcerted reaction pathways was observed. Based upon the conveyed stereochemical information in the reaction product (threo vs. erythro and *cis* vs. *trans*) and the unequivocally determined olefin geometry in each of the four dienols, it is possible to make unambiguous erythro and threo stereochemical assignments to all four dienols and to assign the transition state conformations (boat or chair) interrelating reactants and products. These stereochemical assignments in no way depend upon the a priori assumption of a preferred chair or boat transition state preference, but only upon the postulate that either chair or boat transition states are involved in these rearrangements. On this basis, *trans*-dienol **A** and *cis*-dienol **A**, both of which were derived from the major diastereoisomeric acetylene **11**, are assigned as the threo isomers **6a** and **7a**, respectively. In a similar fashion, *trans*-dienol **B** and *cis*-dienol **B** are assigned as the erythro isomers **6b** and **7b**. The results obtained for the product ratios derived from the four dienols are summarized in Table I.

**Transition State Conformations.** In the rearrangements of all four dienols, chair transition states are preferred. As predicted from conformational analysis of chair and boat transition states, **C<sub>1</sub>** and **B<sub>1</sub>**, the *threo-trans*-dienol **6a** ( $R_1 = H$ ,  $R_2 =$

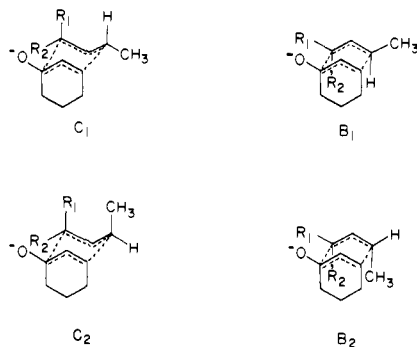

$= OCH_3$ ) should exhibit a larger  $\Delta\Delta G^\ddagger$  between **C<sub>1</sub>** and **B<sub>1</sub>** than the *erythro-trans*-dienol **6b** ( $R_1 = OCH_3$ ,  $R_2 = H$ ).<sup>15</sup> The smaller  $\Delta\Delta G^\ddagger$  observed in the rearrangement of **6b** is to be expected as a result of the destabilizing influence of the pseudo-axial methoxy substituent,  $R_1$ , in the transition state **C<sub>1</sub>**. Likewise, in the rearrangements of diastereoisomeric *cis*-dienols **7a** and **7b**, the chair transition state **C<sub>2</sub>** for **7b** ( $R_1 = OCH_3$ ,  $R_2 = H$ ) is again destabilized by the pseudo-axial methoxy substituent. These arguments correlate well with the observations that alcohols **6a** and possibly **7a** exhibit a greater preference for the chair transition state (96:4 and 98:2) in the Cope rearrangement than do **6b** and **7b** (77:23 and 70:30). Although the original studies by Doering and Roth<sup>16</sup> on the Cope rearrangement showed a large preference for the reaction to proceed via a chair transition state, later work,<sup>17</sup> mainly on Claisen rearrangements, has shown that hindered 3,3-rearrangements often proceed to some extent via boat transition states.

## Conclusions

These results unequivocally demonstrate that the [3,3] sigmatropic rearrangements of 1,5-diene alkoxides possess the stereochemical characteristics of a concerted process. Conse-

Table I. Rearrangement of Dienols **6a**, **6b**, **7a**, **7b**<sup>a</sup>

alcohol	product composition, %			
	<b>8t</b>	<b>9c</b>	<b>8c</b>	<b>9t</b>
<b>6a</b>	96	4	$\leq 1$	$\leq 1$
<b>7b</b>	30	70	$\leq 1$	$\leq 1$
<b>6b</b>	$\leq 1$	$\leq 1$	77	23
<b>7a</b>	$\leq 1$	0-2 <sup>b</sup>	2-0 <sup>b</sup>	98

<sup>a</sup> Conditions: KH, 110 °C, diglyme, <sup>b</sup> **8c** + **9c** = 2%.

quently, these reactions can be employed in a rational fashion in the stereoselective generation of asymmetry. In addition, we have found that dienols which are normally plagued with competing side reactions ( $\beta$ -hydroxy olefin cleavage) can be induced to rearrange in good yield as the conjugate bases. These innovations in the oxy-Cope rearrangement considerably extend the scope of these reactions. Just as important from a mechanistic standpoint, these studies demonstrate that the large rate accelerations associated with the substituent modification ( $R = OH \rightarrow R = O^-M^+$ ) do not change the reaction

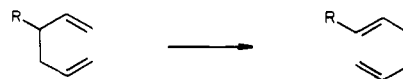

mechanism. It is quite obvious that the concepts embodied in these studies can be applied to numerous other systems. Nonetheless, prior to the association of any mechanistic significance to related rate accelerations, a commonality of mechanism must be demonstrated between the neutral and charged substituents.

## A Stereoselective Synthesis of ( $\pm$ )-Juvabione

Numerous terpenoid natural products possess methyl-bearing stereocenters on side chains proximal to a ring fusion. Examples of molecules embodying this structural feature are the sesquiterpenes *erythro*-juvabione (**15a**) and *threo*-juvabione (**15b**), the sesterterpene ophiobolin C (**16**), as well as steroids (cf. **17**) and numerous triterpenes. Recently, several

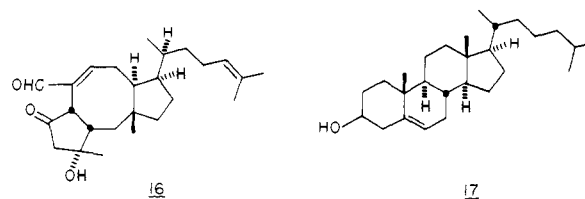
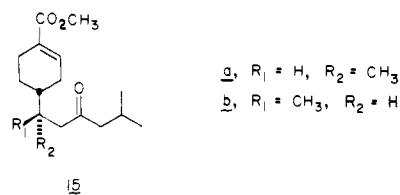

methods have been developed to solve this ubiquitous stereochemical problem among which have been the creative contributions of Trost<sup>18a,b</sup> and Ficini.<sup>18c</sup> The present study reports an alternative protocol for the solution of this problem within the context of a synthesis of ( $\pm$ )-*erythro*-juvabione.

Juvabione, originally isolated by Bowers and co-workers<sup>19</sup> from *Abies balsamea* (L.) Miller, was assigned the structure **15b** by analogy to the stereochemistry of todomatonic acid.<sup>20</sup> However, Saucy and co-workers synthesized both enantiomers of **15a** and **15b** and found that comparison of their ORD spectra with that of the natural product,<sup>21</sup> provided by Cerny,<sup>22</sup> indicated **15a** as the structure of juvabione. Although the source of Cerny's sample was originally believed to be a balsam

Scheme III

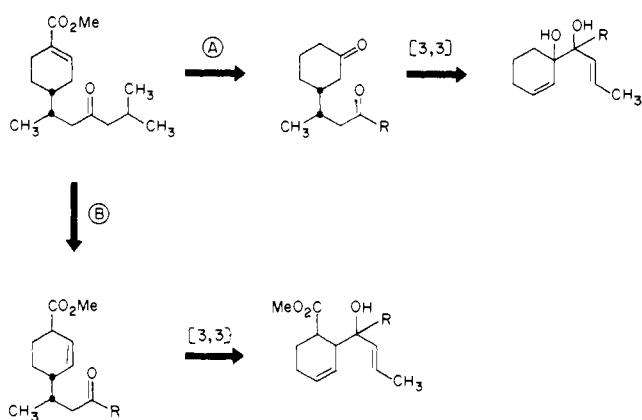

for, this identification has become uncertain.<sup>23</sup> More recently, Manville<sup>23</sup> reexamined juvabione and related compounds isolated from *Abies balsamea* and determined the structure of juvabione to be **15b** by comparison of his ORD spectra with those of Saucy et al. Sakai and Hirose<sup>24</sup> found that juvabione from Douglas fir [*Pseudotsuga menziesii* (Mirb.) Franco] also possesses structure **15b**. Although the identity of the natural source of **15a** is in question, it appears that both **15a** and **15b** are natural products. Due to the fact that both **15a** and **15b** have been extensively referred to as juvabione and *epi*-juvabione, for clarity we shall refer to **15a** and **15b** as *erythro*- and *threo*-juvabione, respectively.

Although *erythro*-juvabione (**15a**) has been the target of numerous synthetic investigations,<sup>18c,21,25</sup> the only stereospecific synthesis has been that reported by Ficini and co-workers.<sup>18c</sup> A general alternative strategy for the synthesis of **15a** is illustrated in Scheme III. In both routes the desired contiguous stereocenters can, in principle, be introduced via related [3,3] sigmatropic rearrangements. In the present study, path A was chosen in conjunction with the general stereochemical investigation of 1,5-diene alkoxide [3,3] sigmatropic rearrangements.

Based on the results presented in the preceding section, the 2:1 mixture of *threo*,*erythro*-dienols **6a**, **6b**, upon conversion to their respective potassium alkoxides with KH, underwent rearrangement in diglyme (110 °C, 37 h) to ketones **8** and **9** in a ratio of 91:9 (77% yield) (Scheme IV). The ratio of **8**:**9** could be improved to 96:4 if pure *threo*-dienol **6a** was employed in the reaction.

Scheme IV

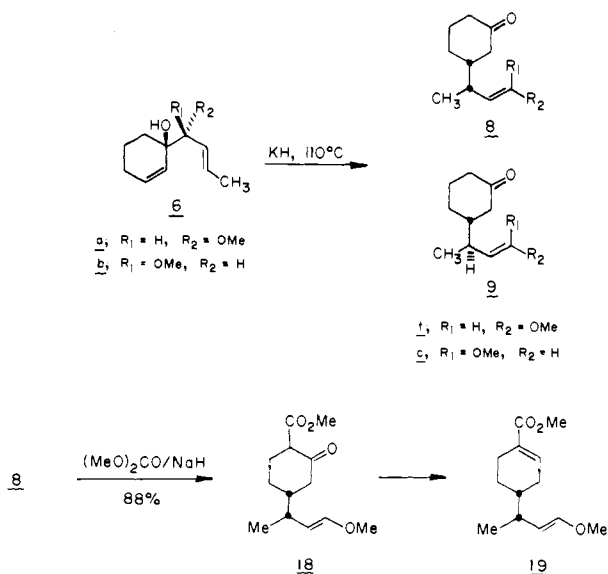

During the course of this investigation, we have found that the conditions employed for these rearrangements are critical. In an attempt to optimize the product ratio **8**:**9**, it was reasoned that the stereoselectivity of the Cope process could be improved if the reaction could be carried out at lower temperatures. Unfortunately, this did not prove to be the case. Employing conditions which are known to provide maximal rate enhancements for these reactions, we have observed some side reactions which become important under these hyperbasic reaction conditions. For example, the rearrangement of **6** at 70 °C with KH in HMPT results mainly in the formation of the unstable trienol **20** whose structure has been tentatively assigned by <sup>1</sup>H NMR. Apparently, the alkoxide is a strong enough base under these conditions to effect elimination of methoxide from **6**. Alternatively, the rearrangement of **6** with

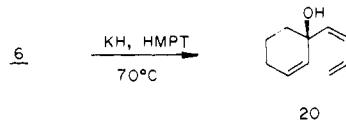

KH in diglyme at 70 °C in the presence of 2 equiv of 18-crown-6 was successful. However, the ratio of **8**:**9** in this instance was 87:13 as compared with a 91:9 ratio in diglyme (110 °C) in the absence of crown reagent. It thus appears that there is a ligand effect associated with 18-crown-6 which decreases the stereoselectivity of this rearrangement.

In the succeeding steps of the synthetic sequence, no effort was made to separate the undesired minor diastereoisomeric ketones (**9t** + **9c**) (9%) formed during the oxy-Cope rearrangement. Carbomethoxylation of **8** followed by reduction (NaBH<sub>4</sub>), esterification (CH<sub>3</sub>SO<sub>2</sub>Cl), and elimination afforded the  $\alpha,\beta$ -unsaturated ester in an overall yield of 38%. In an effort to improve the overall yield in this latter transformation, we have investigated the use of a variant of the recently reported base-catalyzed  $\beta$ -keto ester tosylhydrazone elimination.<sup>26</sup> Based on the premise that *N*-aminoaziridines are tosylhydrazone equivalents (eq 5),<sup>27,28</sup> the hydrazone **21** was

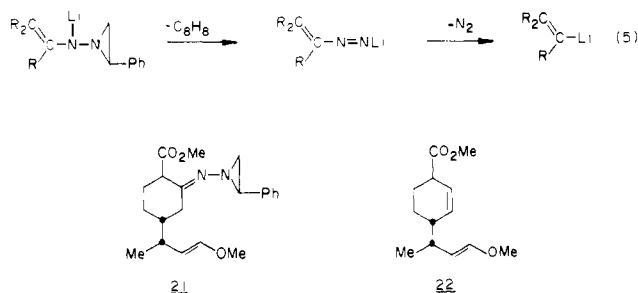

prepared from the reaction of keto ester **18** with 1-amino-2-phenylaziridine.<sup>29</sup> The addition of **21** to 2.7 equiv of lithium diisopropylamide (THF, 0 °C) resulted in the extrusion of styrene and nitrogen; subsequent protonation gave  $\beta,\gamma$ -unsaturated ester **22** which was equilibrated in situ with sodium methoxide to  $\alpha,\beta$ -unsaturated ester **19** in an overall yield of 49%. It is noteworthy that these *N*-aminoaziridines, which are somewhat more nucleophilic than tosylhydrazone itself, appear to be generally applicable to the Shapiro elimination reaction.

The latter stages of the synthetic plan were completed by acid hydrolysis of enol ether **19** followed by in situ oxidation of the resulting aldehyde to the carboxylic acid **23a** with Jones reagent (77% overall). An attempt to effect both hydrolysis and oxidation simply by treatment of **19** with Jones reagent was unsuccessful because the oxidative cleavage of the enol ether was found to be competitive with hydrolysis. The conversion of **23a** to ( $\pm$ )-*erythro*-juvabione (**15a**) via acid chloride **23b** and diisobutylcadmium<sup>30</sup> proceeded in 60% yield. Comparison of the spectra of ( $\pm$ )-**15a** above with spectra of an indepen-

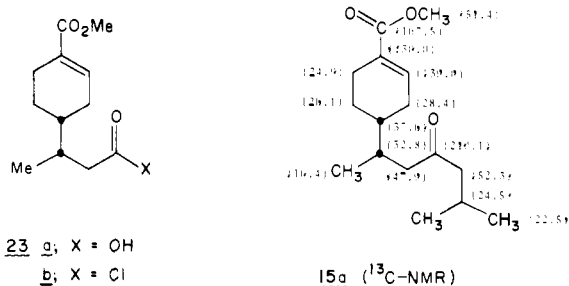

dently prepared sample of ( $\pm$ )-**15a** provided by Professor Ficini indicated that the samples were identical in all respects.

The analysis of juvabione samples for stereochemical purity is complicated by the fact that both diastereoisomers have identical <sup>1</sup>H NMR, IR, mass spectra, and chromatographic properties; however, Manville and Bock<sup>31</sup> recently published carbon-13 NMR data which show differences between the diastereoisomers. Analysis of the ( $\pm$ )-*erythro*-juvabione (**15a**) prepared above indicates the presence of 4–5% of ( $\pm$ )-*threo*-juvabione (**15b**). As discussed earlier, the source of this minor diastereoisomer has been identified with the oxy-Cope rearrangement step in the synthetic sequence.

### Experimental Section

Infrared spectra were recorded on a Beckmann 4210 spectrophotometer. <sup>1</sup>H magnetic resonance spectra were recorded on Varian Associates A-60A (60 MHz) and EM-390 (90 MHz) spectrometers and are reported in ppm from internal tetramethylsilane on the  $\delta$  scale. Data are reported as follows: chemical shift, multiplicity (s = singlet, d = doublet, t = triplet, q = quartet, m = multiplet, b = broad), integration, coupling constant (Hz), and interpretation. <sup>13</sup>C magnetic resonance spectra were recorded on a Varian Associates XL-100 (25.2 MHz) spectrometer and are reported in ppm from tetramethylsilane on the  $\delta$  scale. When multiplicities were determined on the <sup>13</sup>C spectra (by off-resonance decoupling), they are reported by using the abbreviations given above. Mass spectra were recorded on a Du Pont 21-492 B spectrometer. Mass spectral and combustion analyses were performed by the California Institute of Technology Microanalytical Laboratory.

Analytical gas-liquid chromatography was carried out on a Varian Aerograph Model 1400 gas chromatograph equipped with a flame ionization detector using a 6 ft  $\times$  0.125 in. stainless steel column packed with 10% Carbowax 20M on 60–80 mesh Chromosorb W or a 20 ft  $\times$  0.125 in. Analabs Hi-Plate column with OV-17 packing. Preparative gas-liquid chromatography was performed on a Varian Aerograph Model 90-P chromatograph using 6 ft  $\times$  0.25 in. copper column packed with 10% SE-30 on 40–60 mesh Chromosorb W support. Medium pressure chromatography was performed using EM Laboratories LoBar Silica Gel 60 prepacked columns on a Chromatronic MPLC apparatus equipped with a Fluid Metering Inc. Model RP Lab Pump. Silver nitrate impregnated silica gel was made with Silica Gel 60 by the procedure of Djerassi.<sup>12</sup>

When necessary, solvents and reagents were dried prior to use. Tetrahydrofuran, diglyme, and diethyl ether were distilled from benzophenone ketyl. Zinc chloride was fused four times under a vacuum of 0.1 mm. *n*-Butyllithium<sup>32</sup> was titrated by the procedure of Watson and Eastham.<sup>33</sup> Potassium hydride<sup>32</sup> was purchased as a 22% dispersion in mineral oil and was not titrated before use. Reactions requiring an inert atmosphere were run under a blanket of nitrogen unless stated otherwise. All reaction temperatures refer to the reaction itself unless stated otherwise.

**1-(1-Methoxy-2-butynyl)-2-cyclohexen-1-ol (11).** To a  $-70^\circ\text{C}$  solution of 100 mL (71 mmol) of 2.28 M *n*-butyllithium in hexane was added 6.0 g (71 mmol) of 1-methoxy-2-butyne.<sup>6</sup> After 30 min stirring at  $-70^\circ\text{C}$ , a solution of 9.7 g (71 mmol) of zinc chloride in 50 mL of tetrahydrofuran was added to the dark orange reaction to form a cloudy white solution. After 10 min of stirring, 5.7 g (59 mmol) of 2-cyclohexen-1-one was added. The reaction was allowed to warm to room temperature where it was quenched with 10 mL of saturated aqueous ammonium chloride. After the addition of 150 mL ether, the solution was filtered through Celite and concentrated in vacuo to approximately 50 mL of orange oil which was added to 100 mL of

ether. The ether solution was washed once with saturated aqueous sodium bicarbonate and twice with brine, dried ( $\text{Na}_2\text{SO}_4$ ), and concentrated in vacuo to yield 10.8 g of orange oil. Molecular distillation at  $55^\circ\text{C}$  (0.5 mm) yielded 10.2 g (95%) of pale yellow oil: IR (neat) 3500, 3030, 2940, 2300, 2230, 1650, 1450, 1375, 1085, 730  $\text{cm}^{-1}$ ; NMR ( $\text{CDCl}_3$ )  $\delta$  5.77 (m, 2,  $=\text{CH}-$ ), 3.75 (q, 1, propargylic methine), 3.40 (s, 3,  $\text{OCH}_3$ ), 2.38 (b, 1,  $\text{OH}$ ), 2.14 to 1.47 (m, 9, aliphatic including  $=\text{C}-\text{CH}_3$  doublet at 1.85).

Anal. ( $\text{C}_{11}\text{H}_{16}\text{O}_2$ ): C, H.

**1-(1-Methoxy-(*E*)-2-butenyl)-2-cyclohexen-1-ol (6a, 6b).** To a suspension of 1.3 g (33 mmol) of lithium aluminum hydride and 3.6 g (67 mmol) of sodium methoxide in 50 mL of tetrahydrofuran was slowly added 4.0 g (22 mmol) of acetylene **11**. The mixture was heated at reflux for 45 min after which the reaction was quenched at  $0^\circ\text{C}$  by slow addition of 6.2 mL of water. The solution was filtered through Celite and concentrated in vacuo to yield 3.6 g of orange oil. The product was bulb-to-bulb distilled at  $125^\circ\text{C}$  (0.1 mm) to give 3.4 g (85%) of colorless oil: IR (neat) 3500, 3030, 2940, 1660, 1645, 1450, 1375, 1100, 970, 730  $\text{cm}^{-1}$ . Analytical gas-liquid chromatography on the OV-17 column indicated the product contained no (<1%) *cis*-dienol **7**.

Anal. ( $\text{C}_{11}\text{H}_{18}\text{O}_2$ ): C, H.

The diastereoisomers, **6a** and **6b**, were separated by chromatography over silver nitrate impregnated silica gel (25%  $\text{AgNO}_3$  by weight; 100 g of silica gel/g of **6**; eluted with hexane:ethyl acetate, 70:30). **6a** (*trans*-dienol A): <sup>1</sup>H NMR ( $\text{CDCl}_3$ )  $\delta$  5.50 (m, 4,  $=\text{CH}-$ ), 3.25 (d, 1, allylic methine), 3.21 (s, 3,  $\text{OCH}_3$ ), 2.61 (b, 1,  $-\text{OH}$ ), 2.11 to 1.30 (m, 9, aliphatics including  $=\text{CH}-\text{CH}_3$  doublet at 1.72); <sup>13</sup>C NMR ( $\text{CDCl}_3$ )  $\delta$  132.0 (d), 131.0 (d), 128.8 (d), 127.4 (d), 88.8 (d), 70.8 (s), 56.2 (q), 32.4 (t), 25.3 (t), 18.6 (t), 17.9 (q). **6b** (*trans*-dienol B): <sup>1</sup>H NMR ( $\text{CDCl}_3$ )  $\delta$  5.50 (m, 4,  $=\text{CH}-$ ), 3.31 (d, 1, allylic methine), 3.25 (s, 3,  $\text{OCH}_3$ ), 2.30 (b, 1,  $\text{OH}$ ), 2.11 to 1.30 (m, 9, aliphatics including  $=\text{CH}-\text{CH}_3$  doublet at 1.71); <sup>13</sup>C NMR ( $\text{CDCl}_3$ )  $\delta$  131.2 (d), 130.9 (d), 129.6 (d), 126.8 (d), 88.8 (d), 70.8 (s), 56.5 (q), 31.6 (t), 25.4 (t), 18.3 (t), 17.9 (q).

**1-(1-Methoxy-(*Z*)-2-butenyl)-2-cyclohexen-1-ol (7a, 7b).** A rapidly stirred suspension of 3.3 g (18 mmol) of acetylene **11**, 600 mg of 5% palladium on barium sulfate, and 36 drops of quinoline in 100 mL of methanol was hydrogenated at room temperature and atmospheric pressure until 400 mL (18 mmol) of hydrogen had been consumed (1 h). The solution was filtered through Celite and concentrated in vacuo to give a crude product which was chromatographed at medium pressure over silica gel (EM Laboratories size C LoBar column; eluted with hexane:ethyl acetate, 85:15) to yield 2.5 g (76%) of colorless oil: IR (neat) 3500, 3030, 2940, 1650, 1450, 1375, 1100, 730  $\text{cm}^{-1}$ . Analytical gas-liquid chromatography on the OV-17 column revealed that 3% of the product was *trans*-dienol **6**.

Anal. ( $\text{C}_{11}\text{H}_{18}\text{O}_2$ ): C, H.

The diastereoisomers, **7a** and **7b**, were separated (and all but 1% of *trans*-dienol **6** removed) by chromatography over silver nitrate impregnated silica gel (25%  $\text{AgNO}_3$  by weight; 100 g of silica gel/g of **7**; eluted with hexane:ethyl acetate, 70:30). **7a** (*cis*-dienol A): <sup>1</sup>H NMR ( $\text{CDCl}_3$ )  $\delta$  5.50 (m, 4,  $=\text{CH}-$ ), 3.82 (d, 1, allylic methine), 3.25 (s, 3,  $\text{OCH}_3$ ), 2.70 (b, 1,  $\text{OH}$ ), 2.16 to 1.33 (m, 9, aliphatics); <sup>13</sup>C NMR ( $\text{CDCl}_3$ )  $\delta$  131.0 (d), 130.2 (d), 128.5 (d), 127.3 (d), 81.8 (d), 71.2 (s), 56.2 (q), 32.2 (t), 25.4 (t), 18.5 (t), 13.5 (q). **7b** (*cis*-dienol B): <sup>1</sup>H NMR ( $\text{CDCl}_3$ )  $\delta$  5.50 (m, 4,  $=\text{CH}-$ ), 3.82 (d, 1, allylic methine), 3.25 (s, 3,  $\text{OCH}_3$ ), 2.43 (b, 1,  $\text{OH}$ ), 2.16 to 1.33 (m, 9, aliphatics); <sup>13</sup>C NMR ( $\text{CDCl}_3$ )  $\delta$  131.0 (d), 130.3 (d), 129.4 (d), 126.5 (d), 81.8 (d), 71.3 (s), 56.3 (q), 31.3 (t), 25.4 (t), 18.4 (t), 13.7 (q).

**Oxy-Cope Rearrangement of *trans*-Dienols 6a,b.** To a suspension of 2.0 g (50 mmol) of oil-free potassium hydride (from 8.9 g of 22% oil suspension) in 110 mL of diglyme under an argon atmosphere was added 3.0 g (17 mmol) of *trans*-olefin **6**. The solution was heated at  $110^\circ\text{C}$  for 37.5 h. The resulting dark brown solution was added to 50 mL of saturated aqueous ammonium chloride and the aqueous phase extracted twice with pentane. The combined organic extracts were washed once with saturated aqueous ammonium chloride, twice with saturated aqueous sodium bicarbonate, and twice with brine. After drying ( $\text{Na}_2\text{SO}_4$ ), the organic phase was concentrated in vacuo to leave an orange oil which was bulb-to-bulb distilled at 0.05 mm first at  $35^\circ\text{C}$  to remove residual diglyme and then at  $100^\circ\text{C}$  to obtain 2.3 g (77%) of colorless oil: IR (neat) 3030, 2940, 1705, 1650, 1450, 1375, 1100, 940, 760  $\text{cm}^{-1}$ ; NMR ( $\text{CDCl}_3$ )  $\delta$  6.20 (d, 0.6,  $J = 13$ , *trans*- $\text{CH}=\text{CHOCH}_3$ ), 5.88 (d, 0.4,  $J = 6$ , *cis*- $\text{CH}=\text{CH}-\text{OCH}_3$ ), 4.53 (m, 0.6, *trans*- $\text{CH}=\text{CH}-\text{OCH}_3$ ), 4.11 (m, 0.4, *cis*- $\text{CH}=\text{CH}-$

OCH<sub>3</sub>), 3.51 and 3.47 (two s, 3, *cis*- and *trans*-CH=CH—OCH<sub>3</sub>), 2.65 to 1.12 (m, 10, aliphatics), 0.99 and 0.94 (two d, 3, side chain methyl); <sup>13</sup>C NMR (CDCl<sub>3</sub>) δ 212.6 (s, C=O), 147.1 and 145.9 (two d, *cis*- and *trans*-CH=CH—OCH<sub>3</sub>), 109.8 and 105.7 (two d, *cis*- and *trans*-CH—OCH<sub>3</sub>), 59.4 and 55.9 (two q, *cis*- and *trans*-CH=CH—OCH<sub>3</sub>), 46.2 (t), 45.1 (t, weak, other diastereoisomer), 44.9 (d), 44.7 (d), 41.4 (t), 37.7 (d), 33.5 (d), 29.6 (t, weak, other diastereoisomer), 29.1 (t, weak, other diastereoisomer), 27.7 (t), 25.3 (t), 19.2 and 18.3 (two q, side chain methyl).

Anal. (C<sub>11</sub>H<sub>18</sub>O<sub>2</sub>): C, H.

**Oxy-Cope Rearrangement of *cis*-Dienols 7a,b.** The rearrangement of 1.5 g (8.2 mmol) of *cis*-olefin 7 was carried out by the same procedure as for 6 using 0.75 g (19 mmol) of oil-free potassium hydride (from 3.4 g of 22% oil suspension) and 100 mL of diglyme to yield 0.80 g (53%) of colorless oil which contained at least 40% of a side product identified (vide infra) as 1-(1,3-butadienyl)-2-cyclohexen-1-ol. Pure oxy-Cope product was isolated by preparative gas-liquid chromatography and was found to have identical spectral properties as that prepared from the *trans*-olefin 6.

Anal. (C<sub>11</sub>H<sub>18</sub>O<sub>2</sub>): C, H.

The side product could not be separated from the oxy-Cope product by any thin-layer or column chromatography methods examined. Comparison of the spectra of oxy-Cope product isolated by preparative GLC with the spectra of the mixture indicated the presence of a hydroxyl group and an approximate ratio of one olefinic proton for each aliphatic proton. These data implied that the side product was 1-(1,3-butadienyl)-2-cyclohexen-1-ol. The side product was separated from the oxy-Cope product by preparative GLC; however, the highly unstable material (decomposed within 4 h at room temperature) thus obtained exhibited different spectral properties than those seen in the mixture: IR (neat) 3080, 3020, 2940, 1615, 1540, 1000, 940, 890, 690 cm<sup>-1</sup>; NMR (CDCl<sub>3</sub>) δ 6.80 to 4.80 (m, 8, olefins), 2.22 (m, 4, aliphatic). A mass spectrum was also obtained from this compound. These results indicate the formation of 2-(1,3-butadienyl)-1,3-cyclohexadiene from the trienol during separation.

Exact mass calcd for C<sub>10</sub>H<sub>12</sub>: 132.094. Found: 132.092.

**2-(3-Oxocyclohexyl)propanoic Acid (13).** Ozone was bubbled into a -70 °C solution of 250 mg (1.4 mmol) of a 91:9 mixture of 8:9 in 10 mL of acetone until a blue-violet color developed. After flushing with nitrogen, the solution was warmed to 0 °C, whereupon 2 mL (5 mmol) of 2.67 M Jones reagent and 2 mL of water were added. After stirring 2 h at room temperature, the reaction was quenched with isopropyl alcohol. The solution was extracted three times with ether; the ether extracts were washed twice with brine and concentrated in vacuo to give a crude oil. The crude oil was dissolved in 25 mL of ether and the ether solution extracted three times with saturated aqueous sodium bicarbonate. After neutralization (6 N HCl) and saturation with sodium chloride, the aqueous solution was extracted three times with ether. The ether extracts were dried (Na<sub>2</sub>SO<sub>4</sub>) and concentrated in vacuo to yield 137 mg (59%) of tan oil, 94 mg of this oil was bulb-to-bulb distilled at 100 °C (0.01 mm) to yield 85 mg (53% overall) of colorless oil which crystallized on standing. One recrystallization from ethyl acetate-hexane afforded pure erythro acid 13a, mp 77-78 °C (lit.<sup>13</sup> 76 °C) which was identical in all respects with an authentic sample of 13a independently synthesized by Ficini.<sup>14</sup> IR (neat) 3200, 2940, 1700 cm<sup>-1</sup>; NMR (CDCl<sub>3</sub>) δ 9.78 (b, 1, CO<sub>2</sub>H), 2.55-1.30 (m, 10, aliphatics), 1.17 (d, 3, methyl). The NMR spectrum of the unrecrystallized sample revealed a small doublet at δ 1.20 for the three acid 13b (lit.<sup>14</sup> δ 1.21).

Exact mass calcd for C<sub>8</sub>H<sub>14</sub>O<sub>3</sub>: 170.094. Found: 170.089.

**7-Methylbicyclo[4.3.0]non-9-en-2-one (14).** A solution of 150 mg (0.82 mmol) of a 91:9 mixture of 8:9 and 5 mL of 4 N sulfuric acid in 10 mL of tetrahydrofuran was heated at reflux for 4 h. The reaction was quenched by *very slow* addition of solid sodium bicarbonate until no additional gas evolution was seen. The solution was extracted three times with ether. The combined ether extracts were washed with saturated aqueous sodium bicarbonate and brine, dried (Na<sub>2</sub>SO<sub>4</sub>), and concentrated in vacuo to give a quantitative crude yield of yellow oil. Bulb-to-bulb distillation of the crude product at 125 °C (4 mm) yielded 83 mg (67%) of colorless oil: IR (neat) 3030, 2960, 1670, 1605, 1450, 1375 cm<sup>-1</sup>; NMR (CDCl<sub>3</sub>) δ 6.59 (m, 1, =CH), 3.15 to 1.10 (m, 10, aliphatics including a small doublet at 1.16 for minor isomer), 0.85 (d, 3, methyl). Analytical gas-liquid chromatography on the Carbowax 20 M column indicated the minor bicyclic ketone 14b (9%) exhibited a lower retention time than the major product 14a (91%). Separation by preparative gas-liquid chromatography and analysis

by IR, NMR, and mass spectra confirmed that the two products were diastereoisomers.

Exact mass calcd for C<sub>10</sub>H<sub>14</sub>O: 150.105. Found: 150.105 for both products.

**Stereochemical Studies on the Oxy-Cope Rearrangement. *trans*-Dienol A (6a).** The rearrangement of 770 mg of 6a (≥99% pure by GLC) was carried out as described above for the mixture of *trans*-dienols 6a,b to yield 680 mg of crude oil. Analytical GLC using the Carbowax 20M column indicated the ratio (8t + 9t):(8c + 9c) was 96:4. The crude product was chromatographed at medium pressure over silica gel (EM Laboratories size B Lobar column). Elution with hexane:ethyl acetate (95:5) yielded 520 mg of (8t + 9t) (found to contain 1% *cis*-enol ether by GLC) and 16 mg of (8c + 9c) (>99% pure by GLC). Each enol ether was converted to the aldol products 14a,b by the procedure described above. Analytical GLC on the Carbowax 20M column of the products derived from (8t + 9t) indicated the ratio of 14a:14b was 98:2 and on the product derived from (8c + 9c) the ratio of 14a:14b was 4:96. When corrected for the presence of the *cis*-enol ether (1%), the ratio of 8t:9t is calculated to be 99:1. The results indicate a crossover to 9t and 8c of 0.9 and 0.2%, respectively (both less than 1% experimental error).

***trans*-Dienol B (6b).** The stereochemistry of the rearrangement of 6b (containing 1% 6a by GLC) was analyzed by the procedure described for *trans*-dienol 6a. The ratio of (8t + 9t):(8c + 9c) was 23:77. Aldol condensation on the separated *trans*-enol ether (found to contain 1% *cis*-enol ether) gave a ratio of 14a:14b equal to 10:90. Aldol condensation on the separated (8c + 9c) (>99% pure by GLC) gave a product greater than 99% 14a (14b not detected by GLC). After correction for the presence of 6a and *cis*-enol ether, the ratio of 8t:9t is 2:98. These results indicate a crossover to 8t of 0.5% (less than experimental error). No crossover to 9c could be detected.

***cis*-Dienol A (7a).** The rearrangement of 7a (containing 1% 6a by GLC) was carried out as described above. The ratio (8t + 9t):(8c + 9c) was found to be 98:2. Chromatographic separation followed by aldol condensation on the (8t + 9t) mixture (>99% pure by GLC) gave a ratio of 14a:14b equal to 2:98. The *cis*-enol ether could not be recovered after chromatography. After correction for the presence of 6a, the ratio of 8t:9t is 1:99. These results indicate a crossover to 8t of 0.9% (less than experimental error). The maximum crossover possible to 9c is 2%.

***cis*-Dienol B (7b).** The stereochemistry of the rearrangement of 7b (containing 2% 6b by GLC) was analyzed by the procedure described for *trans*-dienol 6a. The ratio (8t + 9t):(8c + 9c) was found to be 30:70. Chromatographic separation of *cis* and *trans* vinyl ethers followed by aldol condensation of the (8t + 9t) mixture (>99% pure by GLC) afforded a ratio of 14a:14b equal to 96:4. Aldol condensation on the (8c + 9c) mixture (>99% pure by GLC) gave a ratio of 14a:14b equal to 3:97. After correction for the presence of 6b, the ratio of 8t:9t is 98:2 and 8c:9c is 1:99. These results indicate a crossover to 9t and 8c of 0.6 and 0.7%, respectively (both less than 1%).

**Methyl 4-(3-Methoxy-1-methyl-(*E,Z*)-2-propenyl)-2-oxocyclohexane-1-carboxylate (18).** To a suspension of 0.33 g (13 mmol) of oil-free sodium hydride (from 0.66 g of 50% oil suspension) in 2.8 g (31 mmol) of dimethyl carbonate and 20 mL of tetrahydrofuran at reflux was added dropwise over 45 min a solution containing 1.2 g (6.3 mmol) of ketone 8 in 10 mL of tetrahydrofuran. The mixture was maintained at reflux for 2 h after the addition was complete. The deep red solution was added to 20 mL of saturated aqueous ammonium chloride and the aqueous phase extracted twice with ether. The combined organic extracts were washed with saturated aqueous sodium bicarbonate and brine, dried (Na<sub>2</sub>SO<sub>4</sub>), and concentrated in vacuo to yield 1.4 g of orange oil. The crude product was bulb-to-bulb distilled at 135 °C (0.08 mm) to yield 1.3 g (88%) of colorless oil: IR (neat) 3030, 2960, 1740, 1705, 1650, 1615, 1450, 1375, 1275, 1200, 1100, 940, 830, 760 cm<sup>-1</sup>; NMR (CDCl<sub>3</sub>) δ 12.00 (b, 0.75, enol hydroxyl), 6.20 (d, 0.6, *J* = 13, *trans*-CH=CH—OCH<sub>3</sub>), 5.88 (d, 0.4, *J* = 6, *cis*-CH=CHOCH<sub>3</sub>), 4.53 (m, 0.6, *trans*-CH=CHOCH<sub>3</sub>), 4.11 (m, 0.4, *cis*-CH=CH—OCH<sub>3</sub>), 3.70 (s, 3, CO<sub>2</sub>CH<sub>3</sub>), 3.51 and 3.47 (two s, 3, *cis*- and *trans*-CH=CH—OCH<sub>3</sub>), 3.31 (m, 0.25, keto tautomer methine), 2.77-1.11 (m, 8, aliphatic), 0.99 and 0.94 (two d, 3, side chain methyl).

Exact mass calcd for C<sub>13</sub>H<sub>20</sub>O<sub>4</sub>: 240.136. Found: 240.133.

**Methyl 4-(3-Methoxy-1-methyl-(*E,Z*)-2-propenyl)-1-cyclohexene-1-carboxylate (19). I. By Reduction, Esterification, and Elimination.** A solution of 780 mg (3.2 mmol) of keto ester 18 and 61 mg (1.6 mmol) of sodium borohydride in 15 mL of isopropyl alcohol



at 0 °C was stirred for 2 h. The solution was then added to 10 mL of brine and extracted three times with ether. The ether extracts were washed with saturated aqueous sodium bicarbonate and brine, dried ( $K_2CO_3$ ), and concentrated in vacuo to yield 710 mg of crude product. The crude product was chromatographed at medium pressure over silica gel (EM Laboratories size B LoBar column; eluted with hexane:ethyl acetate, 85:15) to yield 440 mg (56%) of  $\beta$ -hydroxy ester: IR (neat) 3500, 3030, 2960, 1730, 1650, 1450, 1375, 1250, 1200, 1100, 940, 760  $cm^{-1}$ ; NMR ( $CDCl_3$ )  $\delta$  6.20 (d, 0.6,  $J = 13$ ,  $trans$ - $CH=CH-OCH_3$ ), 5.88 (d, 0.4,  $J = 6$ ,  $cis$ - $CH=CH-OCH_3$ ), 4.53 (m, 0.6,  $trans$ - $CH=CH-OCH_3$ ), 4.11 (m, 0.4  $cis$ - $CH=CH-OCH_3$ ), 3.68 (s, 3,  $CO_2CH_3$ ), 3.51 and 3.47 (two s, 3,  $cis$ - and  $trans$ - $CH=CH-OCH_3$ ), 2.87 (b, 1, OH), 2.55–0.90 (m, 12, aliphatics including side chain methyl doublets at 0.99 and 0.94).

Exact mass calcd for  $C_{13}H_{22}O_4$ : 242.152. Found: 242.153.

To a solution of 720 mg (3.0 mmol) of hydroxy ester and 450 mg (4.4 mmol) of triethylamine in 20 mL of dichloromethane at 0 °C was slowly added 370 mg (3.3 mmol) of methanesulfonyl chloride. The solution was stirred for 30 min at 0 °C, added to 20 mL of 50% aqueous brine, and the organic phase washed twice with saturated aqueous sodium bicarbonate and once with water. After drying ( $Na_2SO_4$ ), the organic phase was concentrated in vacuo to yield 910 mg (96%) of crude mesylate: IR (neat) 3030, 2960, 1735, 1650, 1450, 1350, 1250, 1210, 1175, 1100, 940, 760  $cm^{-1}$ ; NMR ( $CDCl_3$ )  $\delta$  6.20 (d, 0.6,  $J = 13$ ,  $trans$ - $CH=CH-OCH_3$ ), 5.88 (d, 0.4,  $J = 6$ ,  $cis$ - $CH=CH-OCH_3$ ), 4.53 (m, 1.6,  $>CHOSO_2CH_3$  and  $trans$ - $CH=CH-OCH_3$ ), 4.11 (m, 0.4,  $cis$ - $CH=CH-OCH_3$ ), 3.67 (s, 3,  $CO_2CH_3$ ), 3.51 and 3.47 (two d, 3,  $cis$ - and  $trans$ - $CH=CH-OCH_3$ ), 2.97 and 2.94 (two s, 3,  $CH_3SO_3$ ), 2.73–1.11 (m, 8, aliphatics), 0.99 and 0.94 (two d, 3, side chain methyl).

A solution of 910 mg (2.8 mmol) of crude mesylate and 3.10 mg (5.7 mmol) of sodium methoxide (from 130 mg of sodium metal) in 20 mL of methanol was heated at reflux for 8 h; a white precipitate appeared during the reaction. The solution was added to 20 mL of brine and extracted three times with ether. The combined ether extracts were washed with saturated aqueous sodium bicarbonate and brine, dried ( $Na_2SO_4$ ), and concentrated in vacuo to yield a crude yellow oil which was bulb-to-bulb distilled at 115 °C (0.1 mm) to obtain 490 mg (77%, overall 41% from **18**) of colorless oil: IR (neat) 3030, 2960, 1710, 1650, 1450, 1375, 1250, 1210, 1100, 940, 760  $cm^{-1}$ ; NMR ( $CDCl_3$ )  $\delta$  6.94 (m, 1,  $=CH-$ ), 6.20 (d, 0.6,  $J = 13$ ,  $trans$ - $CH=CH-OCH_3$ ), 5.88 (d, 0.4,  $J = 6$ ,  $cis$ - $CH=CH-OCH_3$ ), 4.53 (m, 0.6,  $trans$ - $CH=CH-OCH_3$ ), 4.11 (m, 0.4,  $cis$ - $CH=CH-OCH_3$ ), 3.70 (s, 3,  $CO_2CH_3$ ), 3.51 and 3.47 (two s, 3,  $cis$ - and  $trans$ - $CH=CH-OCH_3$ ), 2.67–1.13 (m, 8, aliphatics), 0.99 and 0.94 (two d, 3, side chain methyl).

Exact mass calcd for  $C_{13}H_{20}O_3$ : 224.141. Found: 224.143.

**II. By Formation of the Hydrazone **21** and Elimination.** To a stirred 0 °C solution of 250 mg (1.0 mmol) of  $\beta$ -keto ester **18** in 5 mL of dichloromethane was added 220 mg (1.1 mmol) of 1-amino-2-phenylaziridine acetate.<sup>29</sup> The resulting solution was stirred for 10 h at 0 °C, after which it was added to 10 mL of saturated aqueous sodium bicarbonate. The aqueous phase was extracted with dichloromethane and the combined organic solution washed with saturated aqueous sodium bicarbonate and brine, dried ( $Na_2SO_4$ ), and concentrated in vacuo to yield 379 mg (102%) of crude hydrazone (**21**): IR (neat) 3060, 3030, 2960, 2880, 1730, 1650, 1630, 1500, 1450, 1210, 750, 700  $cm^{-1}$ ; NMR ( $CDCl_3$ )  $\delta$  7.28 (m, 5, aromatics), 5.40–6.52 (complex m, 1,  $-CH=CH-OCH_3$ ), 3.81–4.80 (complex m, 2,  $-CH=CH-OCH_3$  and  $>CH-CO_2CH_3$ ), 3.15–3.71 (m, 6,  $CO_2CH_3$  and  $-CH=CH-OCH_3$ ), 0.62–3.15 (complex m, 14, aliphatics).

To a stirred 0 °C solution of 280 mg (2.7 mmol) of lithium diisopropylamide in 10 mL of tetrahydrofuran (formed by the reaction of a solution of 320 mg (3.2 mmol) of diisopropylamine in tetrahydrofuran with 1.7 mL (2.7 mmol) of 1.6 M *n*-butyllithium in hexane at –78 °C followed by warming to 0 °C) under an argon atmosphere was dropwise added over 3 min 379 mg (1.1 mmol) of crude hydrazone. The resulting deep red solution was stirred at 0 °C for 6 h. After the addition of a solution of 250 mg (4.6 mmol) of sodium methoxide in 5 mL of methanol, stirring was continued for 3 h at room temperature. The reaction solution was then added to 20 mL of saturated aqueous sodium bicarbonate and the aqueous phase extracted twice with ether. The combined ether extracts were washed with saturated aqueous sodium bicarbonate and brine, dried ( $Na_2SO_4$ ), and concentrated in vacuo to yield 249 mg of brown oil which was chromatographed at medium pressure over silica gel (EM Laboratories size

A LoBar column; eluted with hexane:ethyl acetate, 95:5) to yield 114 mg (49%) of product.

**3-(Methyl-4-carboxyl-3-cyclohexenyl)butanoic Acid (23a).** A solution of 490 mg (2.2 mmol) of ester **19** and 10 mL of 8 N sulfuric acid in 15 mL of acetone was stirred at 0 °C for 4 h. After the addition of 3 mL (8 mmol) of 2.67 M Jones reagent, stirring was continued for 30 min at 0 °C. The reaction was quenched with isopropyl alcohol and the resulting solution extracted three times with ether. The ether solution was washed with brine, dried ( $Na_2SO_4$ ), and concentrated in vacuo to yield 440 mg of a pale yellow oil which crystallized on standing at room temperature overnight. Recrystallization from ethyl acetate/hexane gave 210 mg of analytically pure white crystals, melting point 89–91 °C. The remaining material, which would not crystallize, was purified by preparative thin-layer chromatography on silica gel (eluted with ethyl acetate) and yielded 160 mg of product. Total yield of purified acid was 370 mg (76%): IR ( $CHCl_3$ ) 3400, 3030, 2960, 1700, 1650, 1450, 1375, 1250, 1040  $cm^{-1}$ ; NMR ( $CDCl_3$ )  $\delta$  6.94 (m, 1,  $=CH-$ ), 5.8 (b, 1,  $CO_2H$ ), 3.70 (s, 3,  $CO_2CH_3$ ), 2.70–1.11 (m, 10, aliphatic), 0.97 (d, 3, side chain methyl);  $^{13}C$  NMR ( $CDCl_3$ )  $\delta$  179.3 (s), 167.9 (s), 139.1 (d), 130.3 (s), 51.6 (q), 39.0 (t), 37.4 (d), 34.2 (d), 28.3 (t), 26.1 (t), 24.9 (t), 16.2 (q).

Anal. ( $C_{12}H_{18}O_4$ ): C, H.

**(±)-erythro-Juvabione (15a).** A solution of 175 mg (0.77 mmol) of crystalline acid **23a** and 230 mg (1.8 mmol) of oxalyl chloride in 15 mL of benzene was stirred at room temperature for 3 h. Concentration in vacuo yielded 180 mg (97%) of crude acid chloride: IR (neat) 3030, 2940, 1800, 1710, 1650, 1450, 1375, 1250, 1090  $cm^{-1}$ .

To a 0 °C solution of approximately 1.7 mmol of isobutyl Grignard in 10 mL of ether, generated by the reaction of 42 mg (1.7 mmol) of magnesium turnings with 240 mg (1.7 mmol) of isobutyl bromide, was added 170 mg (0.95 mmol) of anhydrous cadmium chloride. After stirring 5 min at room temperature, the ether was removed by distillation until the reaction was a thick brown slurry, 10 mL of benzene was added, and the solvent again removed by distillation. After the addition of 10 mL of benzene, the reaction was cooled to 0 °C and 180 mg (0.75 mmol) of crude acid chloride was added. The solution was heated at reflux for 1 h, added to 25 g of ice and 25 mL of 10% sulfuric acid, and the aqueous phase was extracted twice with benzene. The combined benzene extracts were washed successively with water, saturated aqueous sodium bicarbonate, water, and brine. After drying ( $MgSO_4$ ), the solution was concentrated in vacuo to yield 200 mg of crude product. The crude product was chromatographed at medium pressure over silica gel (EM Laboratories size B LoBar column; eluted with hexane:ethyl acetate, 95:5) to yield 120 mg (60% from **23a**) of juvabione: IR (neat) 3030, 2960, 1705, 1650, 1450, 1375, 1250, 1090  $cm^{-1}$ ; NMR ( $CDCl_3$ )  $\delta$  6.90 (m, 1,  $=CH-$ ), 3.70 (s, 3,  $CO_2CH_3$ ), 2.67–1.10 (m, 13, aliphatic), 0.90 and 0.86 (two d, 9, side chain methyls);  $^{13}C$  NMR ( $CDCl_3$ )  $\delta$  210.1, 167.5, 139.0, 130.0, 52.3, 51.4, 47.9, 37.6, 32.8, 29.8 (about 4–5% of the height of the 28.4 signal), 28.4, 26.1, 24.9, 24.5, 22.5, 16.4. The assignments of Manville and Bock<sup>31</sup> were used in the analysis.

Exact mass calcd for  $C_{16}H_{26}O_3$ : 266.188. Found: 266.187.

**Acknowledgment.** Support from the National Science Foundation is gratefully acknowledged.

## References and Notes

- (1) National Science Foundation Predoctoral Fellow.
- (2) Evans, D. A.; Golob, A. M. *J. Am. Chem. Soc.* **1975**, *97*, 4765.
- (3) Evans, D. A.; Baillargeon, D. J.; Nelson, J. V. *J. Am. Chem. Soc.* **1978**, *100*, 2242.
- (4) Seebach, D.; Geiss, K.-H.; Pohmakotr, M. *Angew. Chem., Int. Ed. Engl.* **1976**, *15*, 437. Still, W. C. *J. Am. Chem. Soc.* **1977**, *99*, 4186.
- (5) Evans, D. A.; Baillargeon, D. J. *Tetrahedron Lett.* **1978**, 3315, 3319.
- (6) Prepared from propargyl alcohol by the procedure of L. Brandsma: "Preparative Acetylene Chemistry," Elsevier: New York, 1971; pp 38 and 172.
- (7) Mercier, F.; Epszstein, R.; Holand, S. *Bull. Soc. Chim. Fr.* **1972**, 690.
- (8) Kaiser, E. M. *Synthesis* **1972**, 391.
- (9) Magoon, E. F.; Slauch, L. H. *Tetrahedron* **1967**, *23*, 4509.
- (10) Corey, E. J.; Kalzenellenbogen, J. A.; Posner, G. H. *J. Am. Chem. Soc.* **1967**, *89*, 4245. Molloy, B. B.; Hauser, K. L. *J. Chem. Soc., Chem. Commun.* **1968**, 1017.
- (11) Coke, J. L.; Williams, H. J.; Natarajan, S. *J. Org. Chem.* **1977**, *42*, 2380.
- (12) Popov, S.; Carlson, R. M. K.; Wegmann, A.; Djerassi, C. *Steroids* **1976**, *28*, 699.
- (13) Ficinì, J.; Touzin, A. M. *Tetrahedron Lett.* **1972**, 2093, 2097.
- (14) We wish to thank Professor Ficinì for spectra of both **13a** and **13b** and a sample of **13a**.
- (15) Perrin, C. L.; Faulkner, D. J. *Tetrahedron Lett.* **1969**, 2783.



- (16) Doering, W. von E.; Roth, W. R. *Tetrahedron* **1962**, *18*, 67. *Angew. Chem.* **1963**, *75*, 27.
- (17) Hansen, H.-J.; Schmid, H. *Tetrahedron* **1974**, *30*, 1959. Villorelli, P.; Hansen, H.-J.; Schmid, H. *Helv. Chim. Acta* **1975**, *58*, 1293. Jolidon, S.; Hansen, H.-J. *Helv. Chim. Acta* **1977**, *60*, 2436. Lythgoe, B.; Metcalfe, D. A. *Tetrahedron Lett.* **1975**, 2447.
- (18) (a) Trost, B. M.; Verhoeven, T. R. *J. Am. Chem. Soc.* **1978**, *100*, 3435. (b) Trost, B. M.; Taber, D. F.; Alper, J. B. *Tetrahedron Lett.* **1976**, 3857. (c) Ficini, J.; d'Angelo, J.; Noire, J. *J. Am. Chem. Soc.* **1974**, *96*, 1213.
- (19) Bowers, W. S.; Fales, H. M.; Thompson, M. J.; Uebel, E. C. *Science* **1966**, *154*, 1020.
- (20) Nakazaki, M.; Isoe, S. *Bull. Chem. Soc., Jpn.* **1961**, *34*, 741; **1963**, *36*, 1198.
- (21) Pawson, B. A.; Cheung, H.-C.; Gurbaxani, S.; Saucy, G. *J. Chem. Soc., Chem. Commun.* **1968**, 1057. Blouni, J. F.; Pawson, B. A.; Saucy, G. *Ibid.* **1969**, 715. Pawson, B. A.; Cheung, H.-C.; Gurbaxani, S.; Saucy, G. *J. Am. Chem. Soc.* **1970**, *92*, 336.
- (22) Cerny, V.; Dolejs, L.; Labler, L.; Sorm, F.; Slama, K. *Tetrahedron Lett.* **1967**, 1053. *Collect. Czech. Chem. Commun.* **1967**, *32*, 3926.
- (23) Rogers, I. H.; Manville, J. F.; Sahola, T. *Can. J. Chem.* **1974**, *52*, 1192. Manville, J. F. *Ibid.* **1975**, *53*, 1579. *Ibid.* **1976**, *54*, 2365.
- (24) Sakai, T.; Hirose, Y. *Chem. Lett.* **1973**, 491.
- (25) Mori, K.; Maisui, M. *Tetrahedron* **1968**, *24*, 3127. Ayyar, K. S.; Rao, G. S. K. *Can. J. Chem.* **1968**, *46*, 1467. Birch, A. J.; Macdonald, P. L.; Powell, V. H. *J. Chem. Soc. C* **1970**, 1469. Drabkina, A. A.; Tsizin, Y. S. *J. Gen. Chem. USSR (Engl. Transl.)* **1973**, *44*, 422, 691. Trost, B. M.; Tamaru, Y. *Tetrahedron Lett.* **1975**, 3797. Negishi, E.; Sabanski, M.; Katz, J.-J.; Brown, H. C. *Tetrahedron* **1976**, *32*, 925.
- (26) Bunnel, C. A.; Fuchs, P. L. *J. Am. Chem. Soc.* **1977**, *99*, 5184.
- (27) Felix, D.; Müller, R. K.; Horn, U.; Joos, R.; Schreiber, J.; Eschenmoser, A. *Helv. Chim. Acta* **1972**, *55*, 1276.
- (28) Biller, S. A.; Evans, D. A. Unpublished results.
- (29) Müller, R. K.; Joos, R.; Felix, D.; Schreiber, J.; Winiher, C.; Eschenmoser, A. *Org. Synth.* **1976**, *55*, 114.
- (30) Cason, J.; Prout, F. S. *J. Am. Chem. Soc.* **1944**, *66*, 46.
- (31) Manville, J. F.; Bock, K. *Org. Magn. Reson.* **1977**, *9*, 596.
- (32) Purchased from Ventron/Alfa Inorganics.
- (33) Watson, S. C.; Easham, J. F. *J. Organomet. Chem.* **1967**, *9*, 165.

## Total Synthesis of *dl*-Bisnorvernolepin

G. R. Kieczkowski, Martha L. Quesada, and R. H. Schlessinger\*

Contribution from the Department of Chemistry, University of Rochester, Rochester, New York 14627. Received June 4, 1979

**Abstract:** A 19-step total synthesis of the racemic form of bisnorvernolepin, **4**, has been achieved starting from ethyl crotonate. The synthesis is both regiospecific and stereospecific in that it leads to the exclusive formulation of bisnorvernolepin without concomitant formulation of bisnorvernomenin. The synthesis begins with the preparation of compound **5**, a harbinger of the vernolepin B ring and conjoiner of rings A and C. Compound **5** is then converted into the *cis*-2-oxydecalin **20** which is stereoselectively converted into the  $\alpha$ -methoxymethoxy epoxide **28**. Regiospecific ring opening of **28**, facilitated by the chiral center in ring A, followed by successive establishment of the C and A ring lactones yields bisnorvernolepin.

### Background

Since their isolation and characterization by Kupchan,<sup>1</sup> the elemanolide dilactones vernolepin (**1**) and vernomenin (**2**) have elicited a flurry of synthetic activity,<sup>2</sup> culminating in four total syntheses.<sup>3</sup> Quite apart from the pronounced cytotoxic activity of vernolepin, and to a lesser extent vernomenin, interest in the synthesis of these sesquiterpenes derives from the impressive functional and stereochemical array that resides in ring B of these natural products. Grieco's synthesis of desoxyvernolepin (**3**)<sup>4</sup> suggested that bis- $\alpha$ -methylenation of compound **4**, bis-

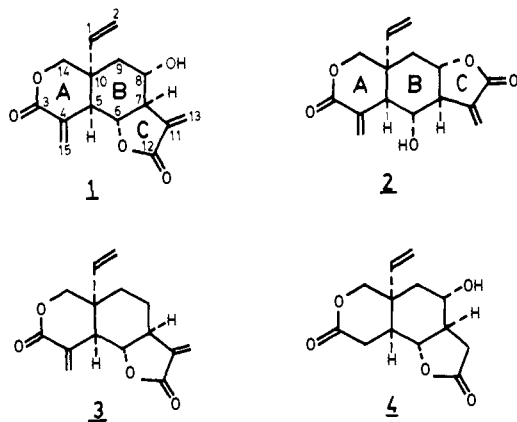

norvernolepin would be feasible, and thus, **4** became our penultimate synthetic target. Indeed, compound **4** became our ultimate objective, because, prior to completion of our work, both Grieco and Danishefsky succeeded in converting **4** into racemic vernolepin.<sup>3</sup>

Having selected our target, we embarked on a series of

retrosynthetic considerations which led to definition of the monocyclic system **5**—a substance whose appeal arises from the chemical flexibility intrinsic to its vinylogous ester residue. Inherent within **5** was the possibility of conjoining another ring to it by attaching, to the hydroxymethyl group of **5**, a two-carbon unit having a terminal electrophilic center. Cyclization via a nucleophilic center developed adjacent to the carbonyl residue was anticipated to yield the *cis*-2-oxydecalin **6**.

Of several avenues now open to fashion the natural product from **6**, one of particular simplicity emerged. Vinylogous esters are known to be reductively convertible into enones.<sup>5</sup> Thus, conversion of **6** into its corresponding enone followed by ste-

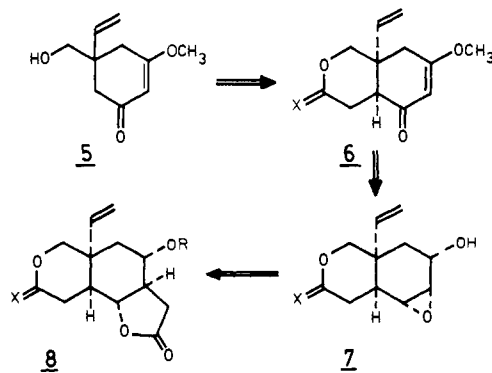

reoselective reduction of this enone into an  $\alpha$ -allylic alcohol<sup>6</sup> and subsequent Henbest epoxidation of the latter would afford the *cis*- $\alpha$ -hydroxy epoxide **7**.<sup>7</sup> Providing the hydroxyl group of **7** were protected in some form, regiospecific and stereospecific epoxide ring opening<sup>8</sup> with a two carbon nucleophile ought to exclusively yield the lactone **8**. Although tenuously defined, this course of action, in principle, would mobilize the